

# hama

00184167  
00184168  
00184169



## BLUETOOTH® EARPHONES

### "Spirit Unchained"

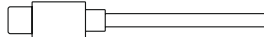
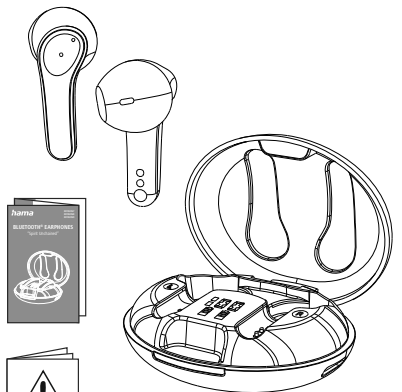
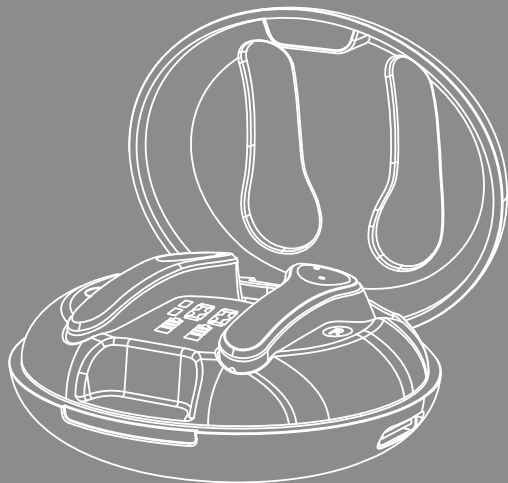

**GB** Read the warnings and safety instructions on the enclosed note before using the product. **D** Lesen Sie vor der Nutzung des Produktes die Warn- und Sicherheitshinweise auf dem beiliegenden Hinweiszettel. **F** Veuillez lire les avertissements et consignes de sécurité de la fiche ci-jointe avant d'utiliser le produit. **E** Antes de utilizar el producto, lea las advertencias e instrucciones de seguridad en la hoja de información adjunta. **NL** Lees voordat u van het product gebruikmaakt, de waarschuwingen en veiligheidsinstructies op het bijgevoegde informatieblad. **I** Prima dell'uso leggere attentamente le indicazioni di avvertimento e di sicurezza riguardanti il prodotto riportate sul foglio illustrativo. **PL** Przed użyciem produktu należy zapoznać się z treścią wskazówek ostrzeżeń i wskazówek bezpieczeństwa znajdujących się na dołączonej ulotce informacyjnej. **H** A termék használatá előtt olvassa el a mellékelt tájékoztatólapon található biztonsági előírásokat és figyelmeztetéseket. **RO** Înainte de utilizării produsului citiți avertizările și instrucțiunile de siguranță de pe fișa cu informații anexată. **CZ** Před použitím si přečtěte výstražné a bezpečnostní pokyny uvedené na letáku přiloženém k produktu. **SK** Pred použitím výrobku si prečítajte výstražné a bezpečnostné upozornenia na priloženom listku s upozornením. **P** Antes da utilização do produto, leia os avisos e as indicações de segurança no folheto de instruções fornecido. **S** Läs varnings- och säkerhetsanvisningarna på medföljande informationsblad innan produkten används. **RUS** Перед использованием изделия ознакомьтесь с приложенными в комплекте правилами техники безопасности и инструкцией за безопасност в приложении информационен лист. **GR** Πριν από τη χρήση του προϊόντος διαβάστε τις υποδείξεις ασφαλείας και προειδοποιήσεις στο παρεχόμενο σημείωμα οδηγιών. **TR** Ürünü kullanmadan önce ekteki bilgi notunda bulunan uyarı ve güvenlik bilgilerini okuyun. **FIN** Lue ennen tuotteen käyttöä ohjelehtissä olevat varoitukset ja turvaohjeet.

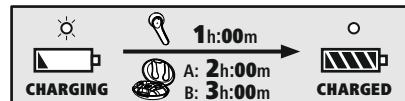
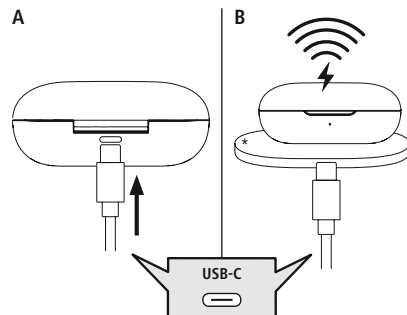
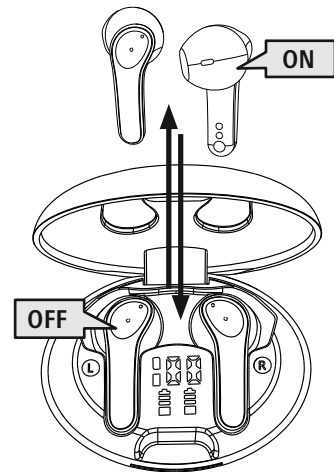

\* Wireless charger not included

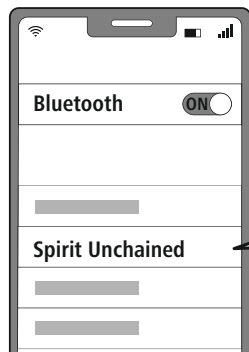
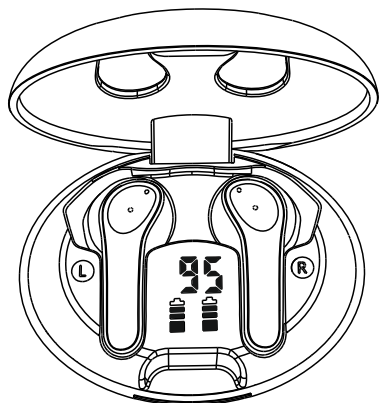

Password

0000



	OFF		
	Siri / Google		



[www.hama.com](http://www.hama.com)

00184167  
00184168  
00184169

→ Downloads



[www.hama.com/184167](http://www.hama.com/184167)

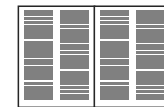

Raccolta Carta

Service & Support

[www.hama.com](http://www.hama.com)

+49 9091 502-0

**D GB**

# **hama**

Hama GmbH & Co KG  
86652 Monheim / Germany

\*The *Bluetooth*® word mark and logos are registered trademarks owned by the Bluetooth SIG, Inc. and any use of such marks by Hama GmbH & Co KG is under license. Other trademarks and trade names are those of their respective owners.\*

All listed brands are trademarks of the corresponding companies. Errors and omissions excepted, and subject to technical changes. Our general terms of delivery and payment are applied.

00184167\_68\_69/11.23